

MOTORE TUBOLARE SOLARE PER AVVOLGIBILI  
CON FINECORSA ELETTRONICO

**IT**

SOLAR TUBULAR MOTOR FOR ROLLER SHUTTERS  
WITH ELECTRONIC LIMIT SWITCH

**EN**

**DE**

**FR**

**ES**



**Table of contents:**

How to prepare the motor .....	p. 23
Electrical connections .....	p. 24
Compatible remote controls.....	p. 25
Key to symbols .....	p. 26
Command sequences example .....	p. 27
Function open/close programming remote control .....	p. 28-29
Setting the first remote control .....	p. 30
Automatic disabling of the first remote control setting function .....	p. 30
Adjustment of the limit switches .....	p. 30
Setting in mode 1 ( <b>manual</b> ) .....	p. 30
Example 1: Setting first the opening position .....	p. 31
Example 2: Setting first the closing position .....	p. 32
Mode 2: limit switch setting ( <b>semi-automatic</b> ) .....	p. 33
Deleting the middle position .....	p. 34
Deleting the opening and closing limit switch .....	p. 34
Obstacle sensitivity setting .....	p. 35
<b>Deleting the limit switch positions</b> .....	p. 36
Deleting the opening limit switch .....	p. 36
Deleting the closing limit switch .....	p. 36
Total deleting of the limit switches .....	p. 36
Setting of additional remote controls .....	p. 37
Remote control memory clearing .....	p. 37
Full memory clearing .....	p. 38
<b>Special functions:</b>	
Short-term setting of a remote control .....	p. 39
Setting the A530058 pocket remote control .....	p. 40
EU Declaration of conformity .....	p. 98

## HOW TO PREPARE THE MOTOR

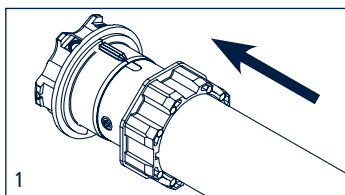
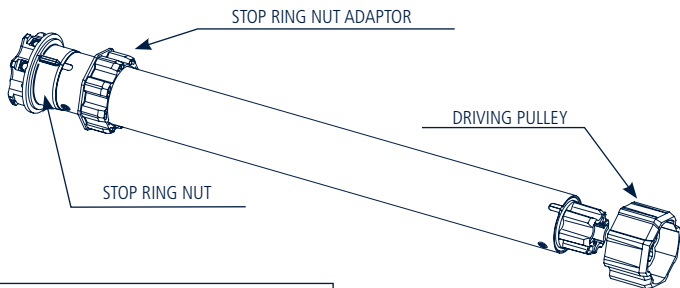

1. Insert the adaptor in the stop ring nut mating the groove with the reference notch and push till they touch.

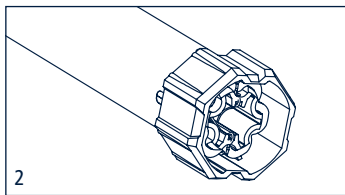

2. Fix the driving pulley on the motor pin until the stop pin clicks.

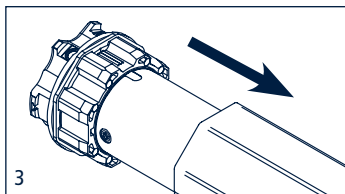

3. Insert the motor fully in the rolling tube.

**NB:** If you use tubes with a round form, the driving pulley must be fixed to the tube, and the installation is to be paid by the person who installs the system. For other tube sections the fitting is optional, but strongly recommended.

## ELECTRICAL CONNECTIONS



Extension cable for connection  
to 24 Vdc power adapter  
(Optional)

24 Vdc power adapter  
(Optional)

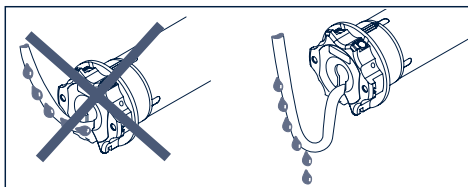
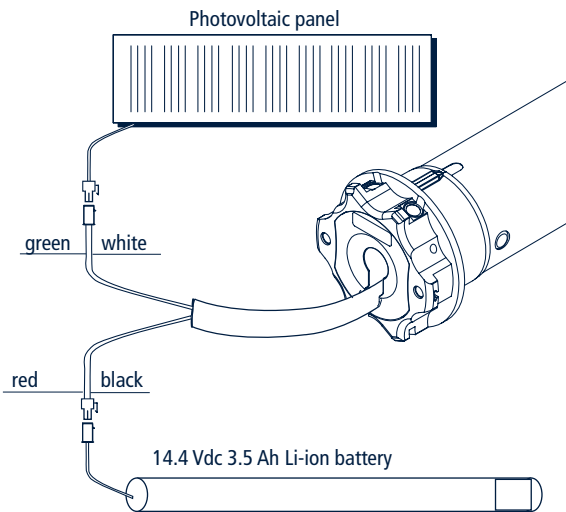

## COMPATIBLE REMOTE CONTROLS

### GIRO

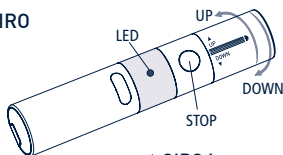

### GIRO Wall

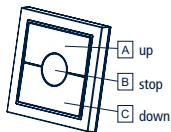

### GIRO Plus

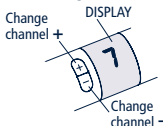

### GIRO Lux

Activating the Sun sensor

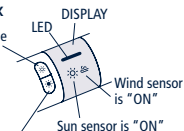

Deactivating the Sun sensor

### GIRO P-Lux

Change channel

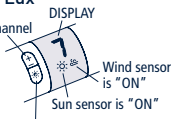

Activating/ Deactivating the Sun sensor

### POP

### POP Lux

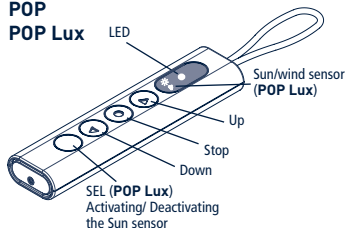

### POP Plus

### POP P-Lux

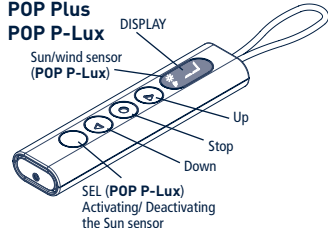

SKIPPER  
SKIPPER Lux  
SKIPPER Plus  
SKIPPER P-Lux

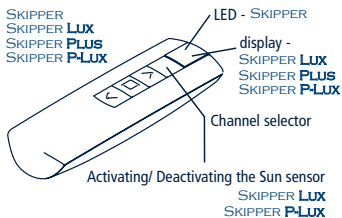

SKIPPER LCD  
SKIPPER SENSO

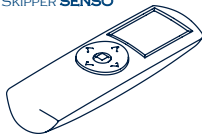

Check the specific instruction book

A530058 Remote Control with 4 independent channels



## KEY TO SYMBOLS

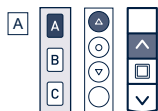
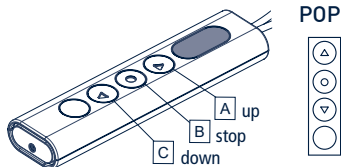
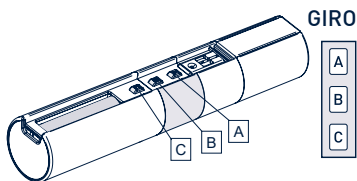
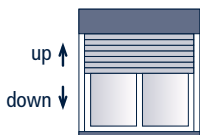

Press button A

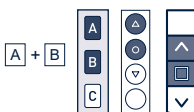

Press buttons A and B  
at the same time

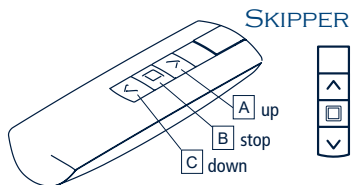

SKIPPER



short motor rotation  
in one direction



long motor rotation  
in other direction



double short  
rotation

## COMMAND SEQUENCES EXAMPLE

Most of the command sequences have three distinct steps, at the end of which the motor indicates if the step has been concluded positively or not, by turning in different ways. This section is provided to demonstrate the motor indications. The buttons must be pressed as shown in the sequence, without taking more than 4 seconds between one step and the next. If more than 4 seconds are taken, the command is not accepted and the sequence must be repeated.

Command sequence example:

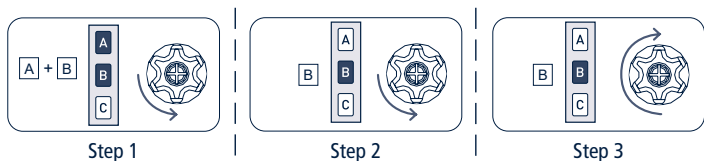

As we can see from the example, when the sequence ends positively, the motor returns to its starting position in one long rotation. In fact, two short rotations in the same direction correspond to one long rotation in the opposite direction. The motor returns to the starting position even when the sequence is not completed; in this case by performing one or two short rotations.

Example of a wrong sequence:

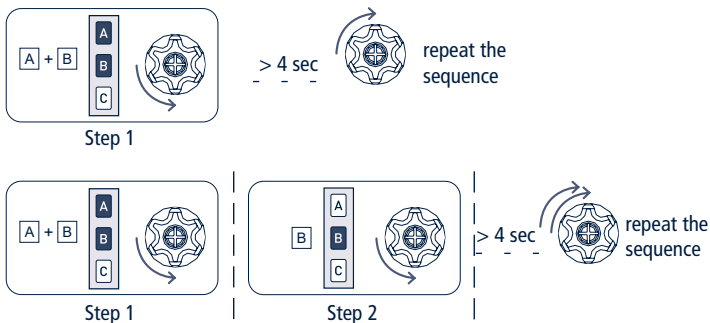



# FUNCTION OPEN/CLOSE PROGRAMMING

## REMOTE CONTROL SKIPPER PLUS - SKIPPER LUX - SKIPPER P-LUX REMOTE CONTROL POP PLUS - POP LUX - POP P-LUX

To prevent accidental changes to the programming of the motor during the daily use of the remote control, the possibility of programming is disabled automatically 8 hours after sending the last sequence (A+B or B+C).

### CHECKING THE STATUS OF THE FUNCTION

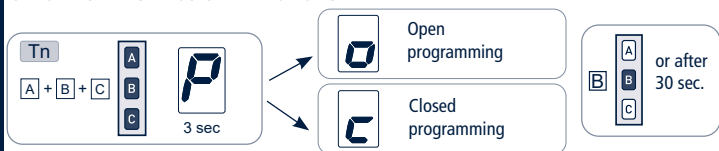

To change the status of the function, see the sequences "ENABLE/DISABLE PROGRAMMING".

### ENABLE PROGRAMMING

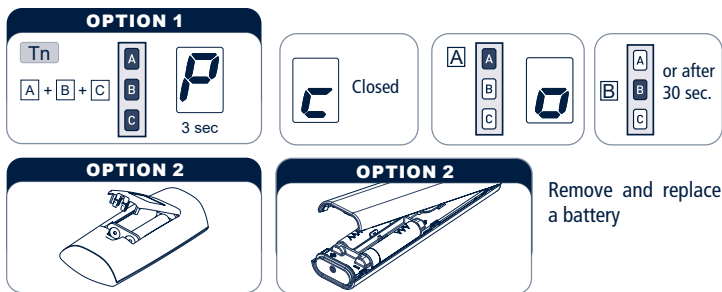

Proceed with programming as the instructions booklet.

### DISABLE PROGRAMMING

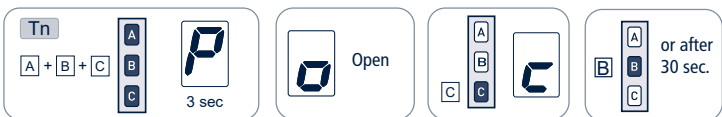

## FUNCTION OPEN/CLOSE PROGRAMMING

### REMOTE CONTROL SKIPPER - SERIES GIRO - REMOTE CONTROL POP

To prevent accidental changes to the programming of the motor during the daily use of the remote control, the possibility of programming is disabled automatically 8 hours after sending the last sequence (A+B or B+C).

#### CHECKING THE STATUS OF THE FUNCTION

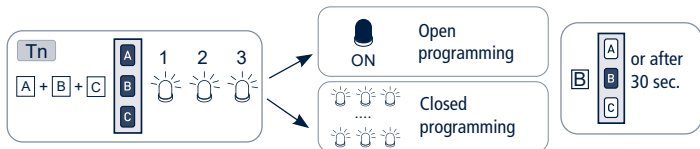

To change the status of the function, see the sequences "ENABLE/DISABLE PROGRAMMING".

#### ENABLE PROGRAMMING

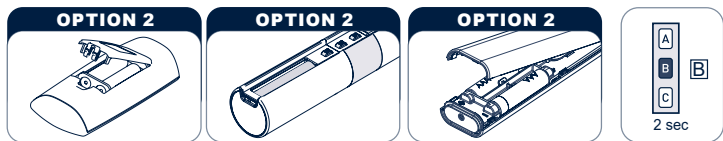
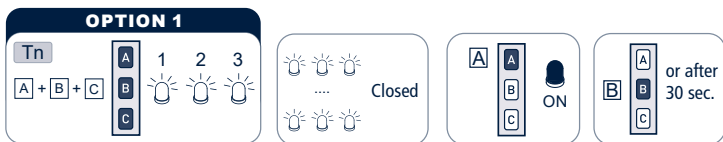

Remove one battery and wait minimum 5 seconds or press any button.

Proceed with programming as the instructions booklet.

#### DISABLE PROGRAMMING



## SETTING THE FIRST REMOTE CONTROL

This operation can only be performed when the motor is new, or after a total delete of the memory.

**During this step, power up only one motor at time!**

T1: First remote control to be set

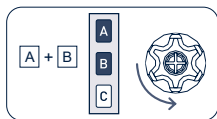

T1

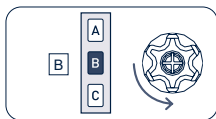

T1

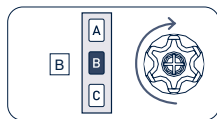

T1 (2 sec)

### AUTOMATIC DISABLING OF THE FIRST REMOTE CONTROL SETTING FUNCTION

Every time you connect the power supply to the motor, you have 3 hours to store the first remote control. After this time, the ability to store the remote control is disabled. To reset the timer of the function you have to disconnect and reconnect the power supply to the motor.

### ADJUSTMENT OF THE LIMIT SWITCHES

LUMEN RX solar motors have an electronic limit switch system with an encoder. This system ensures great reliability and precision in keeping the positions. Limit switch regulation is performed simply with the remote control. During setting, the motor moves only as long as the up or down button is pressed, stopping when the button is released. At the end of setting, press either the up or down button briefly to move the motor. The adjustments of the limit switches can be done in different modes depending on the locking devices fitted to the rolling shutter (plugs and anti-intrusion springs) and the type of installation (factory or site).

#### SETTING IN MODE 1 (manual)

It doesn't matter whether or not the rolling shutter has got physical stops in the opening position and the lockdown hangers in the closing position. It is possible to choose whether to set the upper limit or the lower limit first.

The correct rotation direction will only be identified after the first position is set so it is sometimes necessary to use the "up" or "down" button.

## EXAMPLE 1: Setting first the opening position

### SETTING THE OPENING POSITION

If the rolling shutter is completely open, you have first to drive it down by around 20 cm.

Hold the button A or C pressed and drive the rolling shutter to the opening position.

**With physical stops:** press button A or C until the motor stops automatically.

**Without physical stops:** use the button A or C to drive the rolling shutter to the necessary opening position.

To set the opening position, press buttons A (up) and B (stop) simultaneously for about 2 seconds, until the motor automatically performs a short "down" movement.

This move is the visual confirmation of the setting operation.

Tn: Already programmed remote control

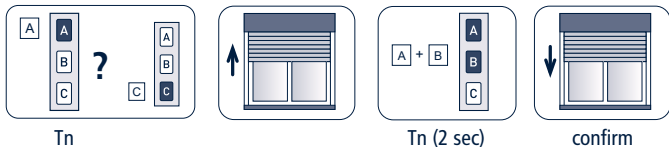

### SETTING THE CLOSING POSITION

Pressing now the button C, drive completely down the rolling shutter to the closing position.

**With lockdown hangers:** press button C until the motor stops automatically.

**Without lockdown hangers:** use the button A or C to drive the rolling shutter to the necessary closing position.

To set the closing position, press buttons B (stop) and C (down) simultaneously for about 2 seconds, until the motor automatically performs a short "up" movement.

This move is the visual confirmation of the setting operation.

Tn: Already programmed remote control

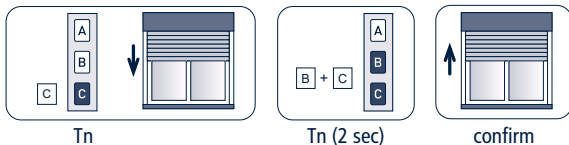

## EXAMPLE 2: Setting first the closing position

### SETTING THE CLOSING POSITION

If the rolling shutter is completely closed, you have first to drive it up by around 20 cm.

Hold the button A or C pressed and drive the rolling shutter to the closing position.

**With lockdown hangers:** press buttons A or C until the motor stops automatically.

**Without lockdown hangers:** use the button A or C to drive the rolling shutter to the necessary closing position.

To set the closing position, press buttons B (stop) and C (down) simultaneously for about 2 seconds, until the motor performs automatically a short "up" movement.

This move is the visual confirmation of the setting operation.

Tn: Already programmed remote control

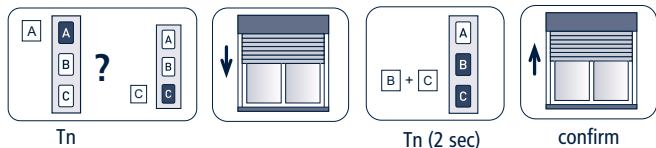

### SETTING THE OPENING POSITION

Pressing now button A, drive completely up the rolling shutter to the opening position.

**With physical stops:** press button A until the motor stops automatically.

**Without physical stops:** use the button A or C to drive the rolling shutter to the necessary opening position.

To set the opening position, press buttons A (up) and B (stop) simultaneously for about 2 seconds, until the motor automatically performs a short "down" movement.

This move is the visual confirmation of the setting operation.

Tn: Already programmed remote control

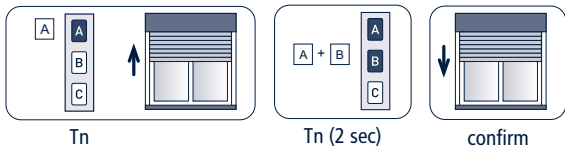

## MODE 2: LIMIT SWITCH SETTING (semi-automatic)

To do the settings in this mode the rolling shutter has to be equipped with lockdown hangers in the closing position, but the rolling shutter does not need to have physical stops in the opening position. This mode of setting is helpful in cases where the factory will set the opening position and the closing position will be set automatically during the normal use.

**In this mode, it's necessary to set first the opening position!! (Rolling shutter open!)**

### SETTING THE OPENING POSITION

**If the shutter is already completely open, you have first to drive it down by about 20 cm.**

Press button A or C and drive the rolling shutter to the opening position.

**With physical stops:** press button A or C until the motor stops automatically.

**Without physical stops:** use buttons A and C to drive the rolling shutter to the necessary opening position.

To set the opening position, press button B (stop) for about 2 seconds, until the motor performs a short downwards movement. After this confirmation movement the motor brings back the rolling shutter to the opening position.

Tn: Already programmed remote control

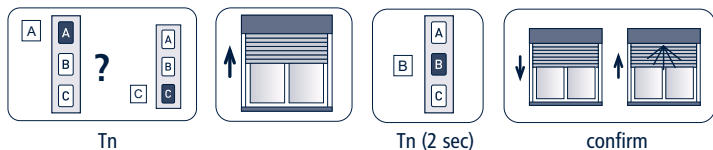

Now the drive direction is detected and the motor can be disconnected from the power. The closing position will be set automatically during the normal use. When the motor is powered up again, the remote control can be used normally. The lower limit switch position will be set automatically the first time the rolling shutter stops automatically in the closing position using the lock down hangers. As the motor looks for a "mechanical" stop during each way down, if the Obstacle Recognition finds something is blocking the way (such as a protruding screw in the guide rails), it is necessary to raise the shutter again, remove the obstacle and to drive the motor back to the closing position to set the limit.

## SETTING A MIDDLE POSITION

This function allows the rolling shutter to be set at a favourite middle position. When this middle position is memorized, you just press the stop button for 2 seconds and automatically the motor will move the shutter to this position.

To memorize the middle position, move the rolling shutter to the desired position and then hold the STOP button down (for about 2 sec) until the motor gives confirmation.

Tn: Already programmed remote control



Tn (4 sec)

### MOVEMENT TO MIDDLE POSITION

It's possible to control the motor in the middle position in two ways:



Tn (2 sec)

## DELETING THE MIDDLE POSITION

If you want to delete the middle position, it can be done as described below.

To change this position, it's also necessary to delete first the memorized middle position.

Before deleting it's necessary to drive the motor to the middle position (by pressing button B for 2 seconds), then press again button B (stop) for about 4 seconds until the motor confirms the operation by a longer movement.

Tn: Already programmed remote control

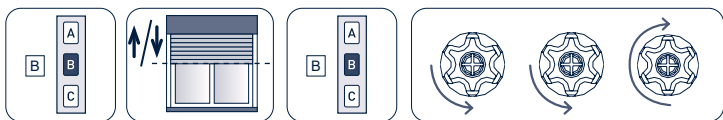

Tn (2 sec)

Tn (4 sec)

## OBSTACLE SENSITIVITY SETTING

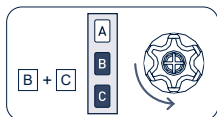

Tn

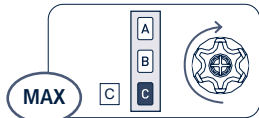
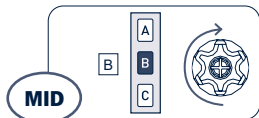
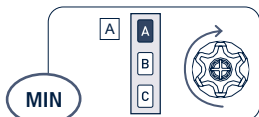
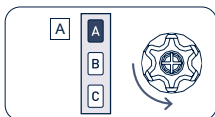

2 sec

The LUMEN RX motor has the option of changing the obstacle detection sensitivity on three levels.

For increased sensitivity select the MAX level, for reduced sensitivity select the MIN level.

The LUMEN RX motor has MID level selected as the factory setting.



## DELETING THE LIMIT SWITCH POSITIONS

### DELETING THE OPENING LIMIT SWITCH

To delete only the opening limit switch perform the following steps and proceed with "SETTING THE OPENING POSITION".

Tn: Already programmed remote control

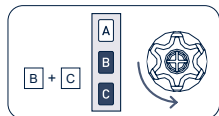

Tn

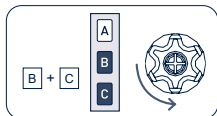

Tn

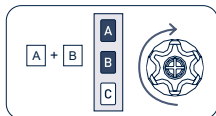

Tn (2 sec)

### DELETING THE CLOSING LIMIT SWITCH

To delete only the closing limit switch perform the following steps and proceed with "SETTING THE CLOSING POSITION".

Tn: Already programmed remote control

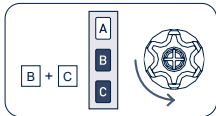

Tn

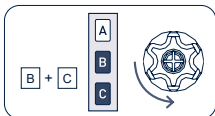

Tn

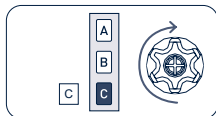

Tn (2 sec)

### TOTAL DELETING OF THE LIMIT SWITCHES

Tn: Already programmed remote control

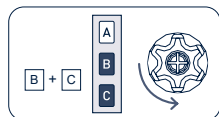

Tn

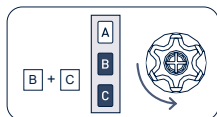

Tn

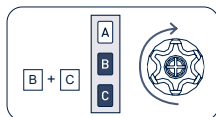

Tn (4 sec)

**NB:** by deleting the limit switches, the setting of the closing force is maintained.

## SETTING OF ADDITIONAL REMOTE CONTROLS

Up to 15 remote controls can be set.

Tn: Already programmed remote control

Tx: Additional remote control

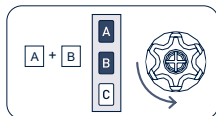

Tn

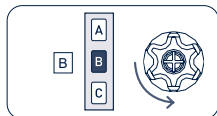

Tn

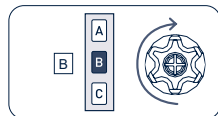

Tx (2 sec)

## REMOTE CONTROL MEMORY CLEARING

It is possible to delete singly all the memorized remote controls. When the last one is deleted the motor initial condition is restored. The same applies to the single channels of a multichannel remote control: just select the channel to cancel before performing the sequence.

Tn: Remote control to be cleared

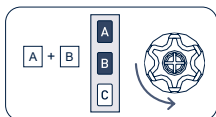

Tn

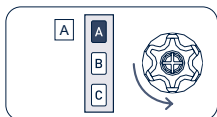

Tn

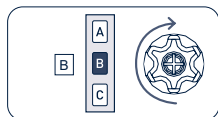

Tn (2 sec)

## FULL MEMORY CLEARING

This full memory clearing does not delete the setting of the limit switch.

The full memory clearing can be performed in two ways:

### 1) WITH THE REMOTE CONTROL

Tn: Already programmed remote control

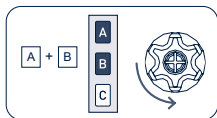

Tn

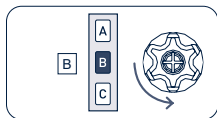

Tn

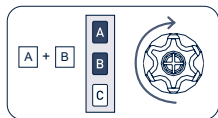

Tn (4 sec)

### 2) WITH BATTERY CONNECTION/DISCONNECTION SEQUENCE

Do this operation only in case of emergency, if all remote controls are no longer operating.

To clear the memory, the battery connection must be accessed.

The sequence of this operation is the following:

- 1) Disconnect the battery and wait at least 15 seconds.
- 2) Connect the battery, after 1 second disconnect it and wait at least 10 seconds.
- 3) Connect the battery and after 1 second the motor will rotate briefly in one direction. Disconnect the battery immediately after the movement and wait at least 10 seconds.
- 4) Connect the battery and after 6 seconds the motor will make a short rotation in the opposite direction to step 3.

At this point it is possible to proceed with the setting of the first remote control.

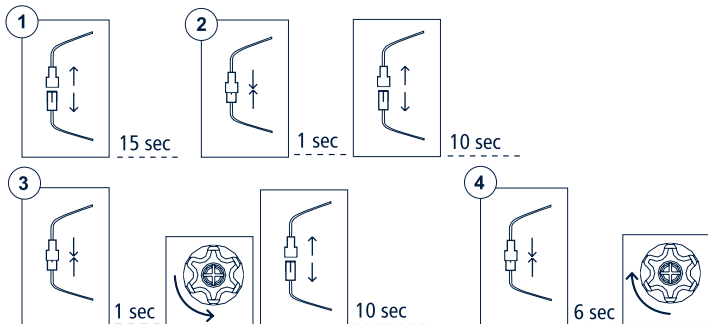

## SPECIAL FUNCTIONS

### SHORT-TERM SETTING OF A REMOTE CONTROL

This function makes it possible to store a remote control temporarily, for example, with the purpose of setting the limit switches during assembly in the factory. A later final saving of the remote control will be possible using the appropriate command sequence (see: "SETTING THE FIRST REMOTE CONTROL"). The operations described below can be carried out only when the motor has just come out of the factory or after a full memory clearing (see: "FULL MEMORY CLEARING"). The motor makes the following operations possible only within the time limits described in order to make sure that the short-term setting is used only in the installation or factory setting phase and not during daily use. Power up the motor, make sure that no other motors having an empty memory are powered up in the same operating range.

**Within 30 seconds after start**, press the B and C buttons simultaneously until the motor gives a confirmation signal.

**The remote control will remain stored for 5 minutes**, while the motor is powered up. After 5 minutes or when the motor has its power cut off, the remote control will be cancelled.

T1: First remote control to be set

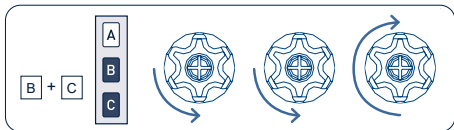

T1

## SETTING THE A530058 POCKET REMOTE CONTROL

NB: The new pocket remote control can be set only after programming of a previous remote control as the traditional Cherubini remote controls (Skipper, Giro or POP - 3 buttons Up-Down-Stop remote control).

### HOW TO PROCEED TO SET THE BUTTON ON THE POCKET REMOTE CONTROL

Tn: Already programmed remote control

Tx: Pocket remote control to be set

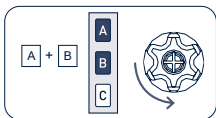

Tn

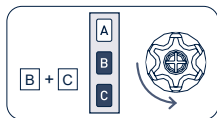

Tn

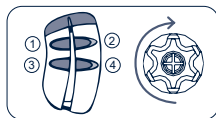

Tx (2 sec)

After to have pressed for minimal 2 seconds one of the 4 buttons on the pocket remote control, this one will be memorized on the step-by-step mode (UP-STOP-DOWN-STOP). The following buttons will be not memorized and have to be done with previous described sequence, and could be used to move additional Tronic RX motors.

### DELETING ONE BUTTON ON THE POCKET REMOTE CONTROL

The buttons saved may be deleted individually according to the following sequence:

Tn: Already programmed remote control

Tx: Pocket remote control with button to be deleted

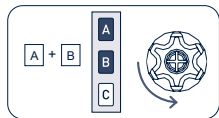

Tn

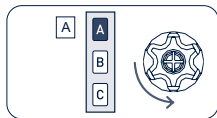

Tn

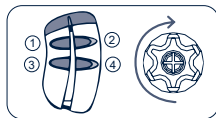

Tx (2 sec)

To confirm the operation the motor will do a short shunt and the button, which has to be pressed for minimal 2 second, will be deleted.

## **IT** DICHIARAZIONE DI CONFORMITÀ UE

**CE** CHERUBINI S.p.A. dichiara che il prodotto è conforme alle pertinenti normative di armonizzazione dell'Unione:

Direttiva 2014/53/UE, Direttiva 2011/65/UE.

Il testo completo della dichiarazione di conformità UE è disponibile facendone richiesta sul sito: [www.cherubini.it](http://www.cherubini.it).

## **EN** EU DECLARATION OF CONFORMITY

**CE** CHERUBINI S.p.A. declares that the product is in conformity with the relevant Union harmonisation legislation:

Directive 2014/53/EU, Directive 2011/65/EU.

The full text of the EU declaration of conformity is available upon request at the following website: [www.cherubini.it](http://www.cherubini.it).

## **DE** EU-KONFORMITÄTSERKLÄRUNG

**CE** CHERUBINI S.p.A. erklärt der produkt erfüllt die einschlägigen Harmonisierungsrechtsvorschriften der Union:

Richtlinie 2014/53/EU, Richtlinie 2011/65/EU.

Der vollständige Text der EU-Konformitätserklärung kann unter unserer Web-Seite [www.cherubini.it](http://www.cherubini.it), gefragt werden.

## **FR** DÉCLARATION UE DE CONFORMITÉ

**CE** CHERUBINI S.p.A. déclare que le produit est conforme à la législation d'harmonisation de l'Union applicable:

Directive 2014/53/UE, Directive 2011/65/UE.

Le texte complet de la déclaration UE de conformité est disponible en faisant requête sur le site internet: [www.cherubini.it](http://www.cherubini.it).

## **ES** DECLARACIÓN UE DE CONFORMIDAD

**CE** CHERUBINI S.p.A. declara que el producto es conforme con la legislación de armonización pertinente de la Unión:

Diretiva 2014/53/UE, Directiva 2011/65/UE.

El texto completo de la declaración UE de conformidad puede ser solicitado en: [www.cherubini.it](http://www.cherubini.it).

**CHERUBINI S.p.A.**

Via Adige 55  
25081 Bedizzole (BS) - Italy  
Tel. +39 030 6872.039  
info@cherubini.it | www.cherubini.it

**CHERUBINI Iberia S.L.**

Avda. Unión Europea 11-H  
Apdo. 283 - P. I. El Castillo  
03630 Sax Alicante - Spain  
Tel. +34 (0) 966 967 504 | Fax +34 (0) 966 967 505  
info@cherubini.es | www.cherubini.es

**CHERUBINI France SAS**

ZI Du Mas Barbet  
165 Impasse Ampère  
30600 Vauvert - France  
Tél. +33 (0) 466 77 88 58  
info@cherubini.fr | www.cherubini.fr

**CHERUBINI Deutschland GmbH**

Siemensstrasse, 40 - 53121 Bonn - Deutschland  
Tel. +49 (0) 228 962 976 34 / 35 | Fax +49 (0) 228 962 976 36  
info@cherubini-group.de | www.cherubini-group.de

